

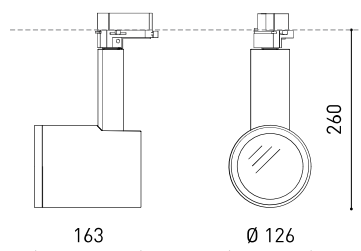

### DIMENSIONI

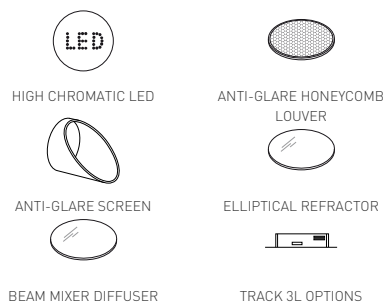

### ACCESSORI



### PREMI



Nome	THOR 2 FLOOD 40° DIM DALI 3000K WT
Articolo	A2262431WT
Colore	Bianco Strutturato
RAL	9016
Categoria	TRACKLIGHTS

### SORGENTE DI LUCE

Tipo	LED
Flusso luminoso lordo	4750 lm
Temperatura di colore	3000 K - Altri K, consultare
Stabilità cromatica	MacAdam Step 2
Indice di Riproduzione Cromatica	CRI > 90
Potenza	36 W
Corrente	1050 mA
Efficienza	132 lm/W
Ore di vita del LED	L90B10 > 55.000h

### APPARECCHIO | DATI FOTOMETRICI

Efficienza luminosa	90%
Angolo del fascio di luce	40°

### APPARECCHIO | DATI ELETTRICI

Driver	Incluso
Valori di potenza del sistema	40,00 W
Tensione	220V/240V
Frequenza	50/60 Hz
Regolazione	DALI
Classe di isolamento elettrico	⊕

### ALTRI DATI

Tenuta stagna	IP20
Wireless control	Consultare
Angolo di oscillazione	90°
Angolo di rotazione	325°
Tipo de carril	Track 3L+N Dimmable
Peso	2015 g
Peso compresso l'imballaggio	2300 g
Dimensioni dell'imballaggio	368 x 171 x 184 mm
Unità per imballaggio	1
Materiali	Alluminio / Vetro Trasparente



Tra i proiettori ad alto flusso luminoso del mercato, Thor è il più compatto, e funziona a dissipazione passiva. Inoltre, grazie al driver integrato nel braccio della lampada, si ottiene una distribuzione centrale della massa stabile. Ciò gli consente un'orientazione in qualsiasi direzione, senza provocare inclinazione del binario.

DIAGRAMMA DI ABBAGLIAMENTO POLARE



DIAGRAMMA CONICO



PER PRESENTAZIONE COMMERCIALE DEL PRODOTTO

Vivid Model Colour Temperature	2700K	3000K	3500K	4000K	Light Pink
📖 Reading			•	•	
🥬 Fruits & Vegetables		•	•		
🍞 Bakery	•				
👤 Retail		•	•		
💄 Cosmetics			•	•	
🍖 Meat					•
🐟 Fish				•	
🐠 Seafood				•	•

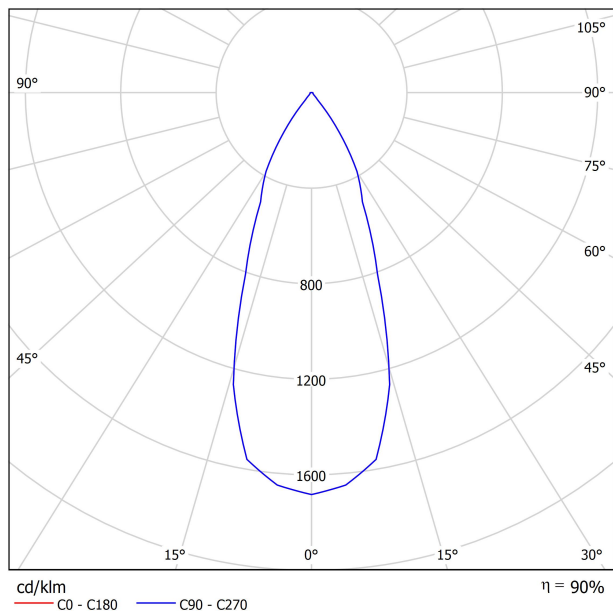
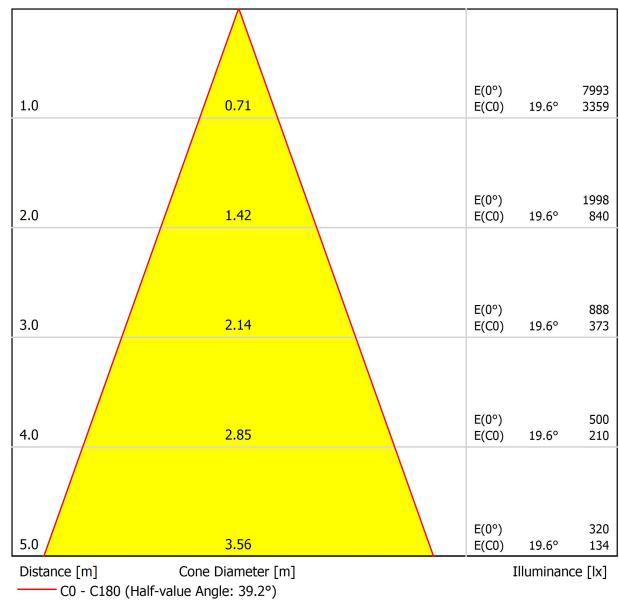

Arkosligh offre su alcuni dei suoi prodotti la possibilità di dotarli di un LED speciale per illuminazione orientata alla promozione visiva di beni e prodotti a scopo commerciale.

Si tratta di un LED ad alta cromaticità che mette in rilievo le tonalità che favoriscono la percezione psicologica positiva dell'oggetto illuminato.

Questa sorgente di luce LED speciale offre una gamma di colori più attraenti e intensi, superiore a quella che può offrire un LED convenzionale. Ciò si ottiene grazie alla configurazione del LED secondo un "parametro speciale di saturazione" che fa in modo che i colori e la texture degli oggetti appaiano più attraenti all'interno dello spettro di luce visibile. A tale scopo si seleziona, in ciascun caso, l'apposito diodo e il suo fosforo di rivestimento specifico.



	PRODUCT
Model	Anti-glare Honeycomb Louver
Reference	08020200
Category	Accessories

NON SI VENDE SEPARATAMENTE.



Accessorio formato da una griglia a forma di pannello d'ape per ridurre l'abbagliamento e l'incidenza diretta dei raggi durante la visione.



	PRODUCT
Model	THOR Anti-glare Screen
Reference	08020000WT
Colour	WT □   Textured white
Category	Accessories

Schermo accessorio per orientare il fascio di luce in modo asimmetrico ed ottenere, da un lato, la riduzione dell'abbagliamento e, dall'altro, una distribuzione luminosa ad incidenza laterale (adeguata per applicazioni di wall washer, tra le altre cose).



	PRODUCT
Model	Elliptical Refractor
Reference	08020400
Category	Accessories

NON SI VENDE SEPARATAMENTE.

Lente che riformula il fascio di luce per ottenere una forma ellittica tramite la rifrazione della luce sul suo vetro ottico.



	PRODUCT
Model	Beam Mixer Diffuser
Reference	08050300
Category	Accessories

NON SI VENDE SEPARATAMENTE.

Il Diffusore di fascio luminoso misto serve ad uniformare gli effetti distorsivi del fascio luminoso dovuti ai collimatori con lente parabolica, di Fresnel o TIR senza un allargamento significativo.

L'eccezionale design "misto" assicura una migliore uniformità del campo lontano e una miscelazione cromatica con una straordinaria luminosità assiale. Rispetto ai diffusori tradizionali, mantiene una maggiore intensità luminosa in candele al centro del fascio (CBCP) e diminuisce la sgradevole "luce a lunga gittata" negli angoli più ampi.

## TRACK 3L+N SURFACE & SUSPENDED

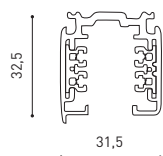

TRACK 3L 1M	A219-21-01-	B	N
TRACK 3L 2M	A219-21-02-	B	N
TRACK 3L 3M	A219-21-03-	B	N



## TRACK 3L+N FLUSH MOUNTING

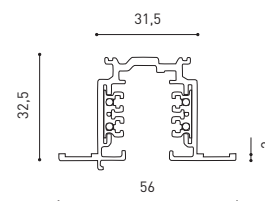
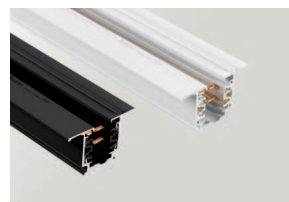

TRACK 3L FLUSH 1M	A219-22-01-	B	N
TRACK 3L FLUSH 2M	A219-22-02-	B	N
TRACK 3L FLUSH 3M	A219-22-03-	B	N

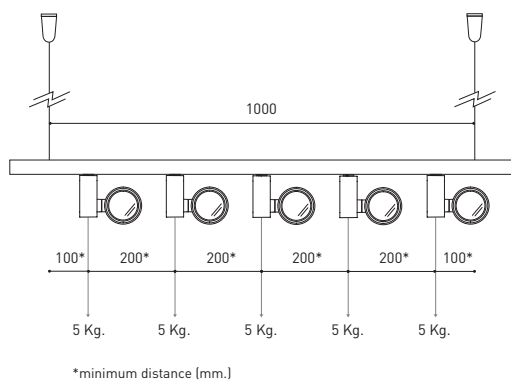

## WEIGHT BEAR CAPACITY

Distancia de fijación y capacidad de carga.  
Distancia de fijación recomendada l- 1000mm.

Fastening distance and loading capacity.  
Recommended fastening distance l- 1000mm.

Distance de fixation et capacité de charge.  
Distance de fixation recommandée l- 1000mm.

Distanza di installazione e capacità di carico.  
Distanza consigliata di fissazione l- 1000mm.

Befestigungsabstand und Belastbarkeit.  
Empfohlener Abstand l- 1000mm.

COLOUR | B □ RAL 9016 | N ■ RAL 9005 |

Calle N · Pol. Ind. EL OLIVERAL  
46394 Ribarroja del Turia · Valencia (Spain)  
Tel. +34 961 667 207 · Fax +34 961 667 054  
info@arkoslight.com · www.arkoslight.com





## SURFACE & SUSPENDED

## FLUSH MOUNTING

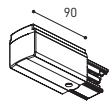

POLARITY GROOVE



**TRACK 3L Live-End Connector**

A219-21-04- | B | N |

A219-21-12- | B | N |

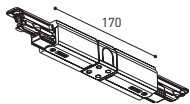

**TRACK 3L Central Connector**

A219-21-05- | B | N |



**TRACK 3L Ceiling Kit**

A219-21-06- | B | N |

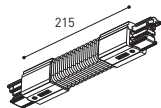

**TRACK 3L Universal Angle**

A219-21-07- | B | N |

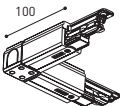

**TRACK 3L 90° Angle**

A219-21-08- | B | N |

A219-21-13- | B | N |

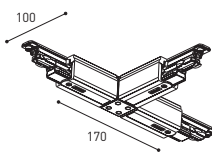

**TRACK 3L T Joint**

A219-21-09- | B | N |

A219-21-14- | B | N |

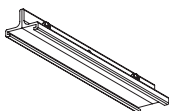

**TRACK 3L Mechanical Joint**

A219-21-11- | B | N |



**TRACK 3L Suspension Kit**

A219-21-10- | B | N |

At least 2 units needed

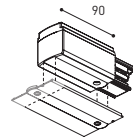

POLARITY GROOVE



**TRACK 3L Live-End Connector**

A219-21-04- | B | N |

A219-21-12- | B | N |

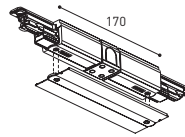

**TRACK 3L Central Connector**

A219-21-05- | B | N |



**TRACK 3L FLUSH Ceiling Kit**

A219-22-06- | B |

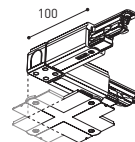

**TRACK 3L 90° Angle**

A219-21-08- | B | N |

A219-21-13- | B | N |

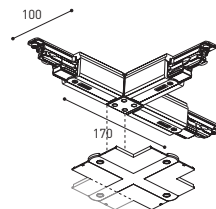

**TRACK 3L T Joint**

A219-21-09- | B | N |

A219-21-14- | B | N |

**TRACK 3L FLUSH Corner Cover Plate**

A219-22-11- | B | N |

Mandatory for installation

Mandatory for installation

## SURFACE & SUSP. / FLUSH MOUNTING

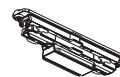

**TRACK Contact Joint**

A219-20-01- | B | N |



**TRACK End**

A219-20-02- | B | N |



**TRACK Clamp Kit for M6 ROD**

A219-21-21- | B |

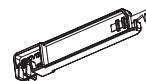

**TRACK Bending Tool**

A282-00-00

For tracks its length has been modified

COLOUR | B □ RAL 9016 | N ■ RAL 9005 |



Fuente de luz (LED) reemplazable por un profesional autorizado  
 Replaceable (LED only) light source by an authorized professional.  
 Source lumineuse (LED) remplaçable par un professionnel agréé  
 Sorgente luminosa (LED) sostituibile da parte di un professionista autorizzato  
 Austauschbare (LED) Lichtquelle durch einen autorisierten Fachmann



Equipo de control reemplazable por un profesional autorizado  
 Replaceable control gear by an authorized professional  
 Dispositif de commande remplaçable par un professionnel agréé  
 Alimentatore sostituibile da parte di un professionista autorizzato  
 Auswechselbares Betriebsgerät durch autorisierten Fachmann

INSTRUCCIONES PARA EL FINAL DE VIDA Y LA ELIMINACIÓN LOS COMPONENTES  
 INSTRUCTIONS ON END-OF-LIFE AND COMPONENT DISPOSAL  
 INSTRUCTIONS POUR LA GESTION DES COMPOSANTS EN FIN DE VIE ET LEUR MISE AU REBUT  
 ISTRUZIONI PER IL FINE VITA E LO SMALTIMENTO DEI COMPONENTI  
 ANWEISUNGEN ZUR ENTSORGUNG DER LEUCHTENKOMPONENTEN



Interrumpir la alimentación del aparato  
 Cut the power supply to the luminaire  
 Couper l'alimentation du luminaire  
 Interrompere l'alimentazione dell'apparecchio  
 Stromversorgung der Leuchte unterbrechen



Quitar la(s) fuente(s) de luz para el desecho  
 Remove light source(s) for disposal  
 Retirer la (les) source(s) lumineuse(s) pour l'élimination  
 Rimuovere la/le sorgente/e di luce per lo smaltimento  
 Lichtquelle(n) zur Entsorgung entfernen



Quitar la batería para el desecho  
 Remove the battery for decommissioning  
 Retirer la batterie pour sa mise au rebut  
 Rimuovere la batteria per la dismissione  
 Die Batterie ordnungsgemäß entsorgen



Quitar el equipo de control para el desecho  
 Remove control gear for disposal  
 Retirer le dispositif de commande pour l'élimination  
 Rimuovere l'alimentatore per lo smaltimento  
 Betriebsgerät zur Entsorgung ausbauen

Enviar los materiales a un centro de recogida RAEE  
 Send the materials to a WEEE collection centre  
 Envoyer les matériaux dans une déchetterie DEEE  
 Inviare i materiali ad un centro di raccolta RAEE  
 Die Materialien in einem WEEE-Zentrum entsorgen

