



DIMENSIONI



ACCESSORI



DRIVER OPTIONS



CONNECTOR IP67



ANTI-GLARE SCREEN

Nome	SKIP FLOOD DIM DALI 2700K GT
Articolo	A4970230GT
Colore	Grigio Strutturato
RAL	7021
Categoria	OUTDOOR

PRODOTTO

SKIP FLOOD DIM DALI 2700K GT

A4970230GT

Grigio Strutturato

7021

OUTDOOR

SORGENTE DI LUCE

LED

620 lm

2700 K

MacAdam Step 2

CRI > 90

5,5 W

500 mA

113 lm/W

L90B10 > 108.000h

APPARECCHIO | DATI FOTOMETRICI

89%

35°

APPARECCHIO | DATI ELETTRICI

Incluso

6,82 W

48Vdc

DALI

III

ALTRI DATI

IP65

360°

360°

Sì

510 g

620 g

226 x 159 x 90 mm

1

Alluminio / Acrilnitrile Butadiene Stirene / Policarbonato



Tipo	LED
Flusso luminoso lordo	620 lm
Temperatura di colore	2700 K
Stabilità cromatica	MacAdam Step 2
Indice di Riproduzione Cromatica	CRI > 90
Potenza	5,5 W
Corrente	500 mA
Efficienza	113 lm/W
Ore di vita del LED	L90B10 > 108.000h

Efficienza luminosa	89%
Angolo del fascio di luce	35°

Driver	Incluso
Valori di potenza del sistema	6,82 W
Tensione	48Vdc
Regolazione	DALI
Classe di isolamento elettrico	III

Tenuta stagna	IP65
Angolo di oscillazione	360°
Angolo di rotazione	360°
Uso in esterni	Sì
Peso	510 g
Peso compresso l'imballaggio	620 g
Dimensioni dell'imballaggio	226 x 159 x 90 mm
Unità per imballaggio	1
Materiali	Alluminio / Acrilnitrile Butadiene Stirene / Policarbonato

Questo proiettore per esterni riunisce semplicità, funzionalità ed estetica. La timida presenza di un proiettore installato con picchetto garantisce il protagonismo all'oggetto illuminato tramite una luce versatile.

DIAGRAMMA DI ABBAGLIAMENTO POLARE



DIAGRAMMA CONICO





	P	V	D (A x B x C)
CONSTANT VOLTAGE LED POWER SUPPLY	0434-01-62	150W	48V
			350 x 30 x 18mm
220 V~ 240			IP20 TO BE INSTALLED ON REMOTE

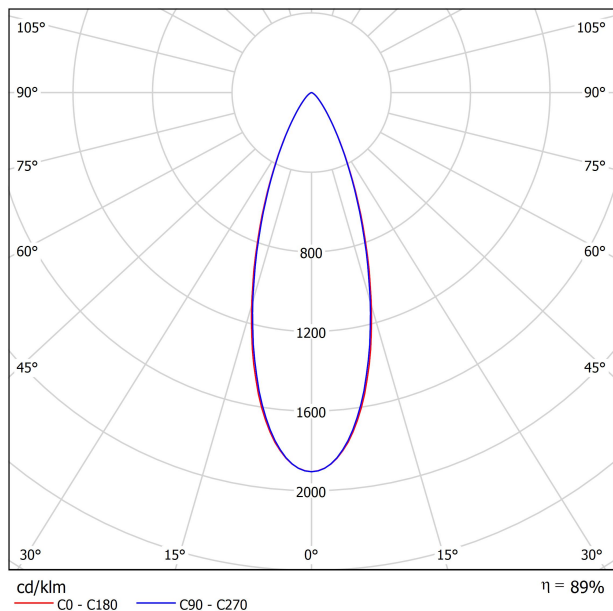
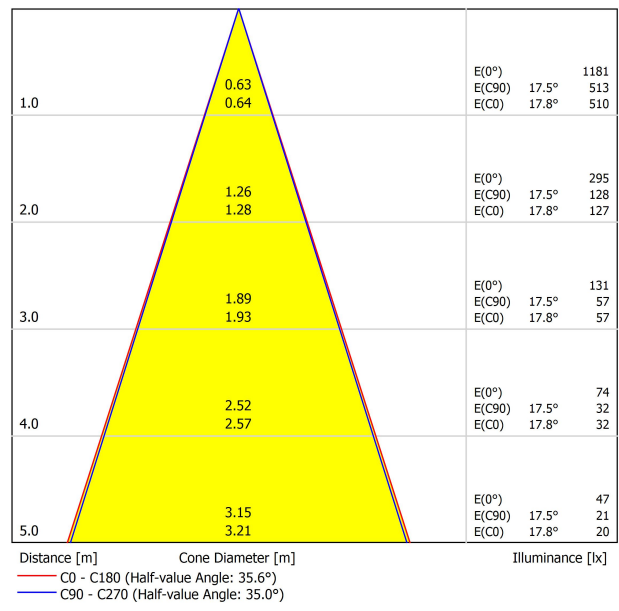
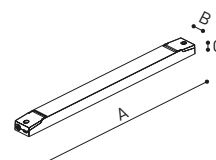

DROP VOLTAGE TABLE

POWER (W)	CABLE SECTION (mm ²)	CABLE LENGHT (m)			
		<25	<50	<75	<100
150	0,75	✓	✓	✗	✗
	1,0	✓	✓	✓	✗
	1,5	✓	✓	✓	✓

IP67 CONNECTOR

ARKOSLIGHT

OPTIONAL ACCESSORY

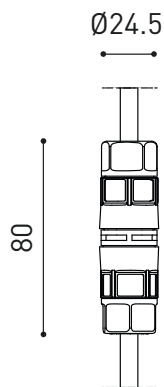

PRODUCT	
Model	Connector IP67 Dim DALI
Reference	0434-01- 83 N
Category	Accessories

For cable $\text{Ø}4,5 - 7,5\text{mm}$ | section $\leq 1,5\text{mm}^2$

IP67 CONNECTOR

ARKOSLIGHT

OPTIONAL ACCESSORY

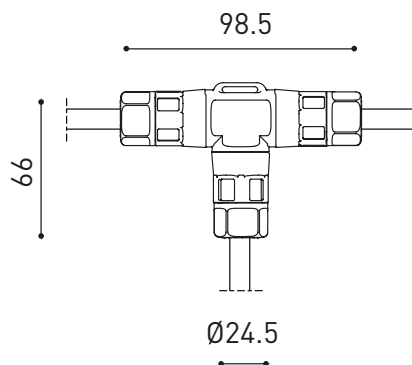

	PRODUCT
Model	Connector IP67 Dim DALI
Reference	0434-01- 84 N
Category	Accessories

For cable Ø4,5 -7,5mm | section ≤ 1,5mm²

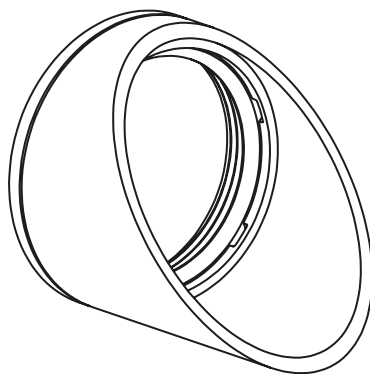

	PRODUCT
Model	SKIP Anti-glare Screen
Reference	A497-00-00 GT OX
Category	Accessories



Fuente de luz (LED) reemplazable por un profesional autorizado
 Replaceable (LED only) light source by an authorized professional.
 Source lumineuse (LED) remplaçable par un professionnel agréé
 Sorgente luminosa (LED) sostituibile da parte di un professionista autorizzato
 Austauschbare (LED) Lichtquelle durch einen autorisierten Fachmann



Equipo de control reemplazable por un profesional autorizado
 Replaceable control gear by an authorized professional
 Dispositif de commande remplaçable par un professionnel agréé
 Alimentatore sostituibile da parte di un professionista autorizzato
 Auswechselbares Betriebsgerät durch autorisierten Fachmann

INSTRUCCIONES PARA EL FINAL DE VIDA Y LA ELIMINACIÓN LOS COMPONENTES
 INSTRUCTIONS ON END-OF-LIFE AND COMPONENT DISPOSAL
 INSTRUCTIONS POUR LA GESTION DES COMPOSANTS EN FIN DE VIE ET LEUR MISE AU REBUT
 ISTRUZIONI PER IL FINE VITA E LO SMALTIMENTO DEI COMPONENTI
 ANWEISUNGEN ZUR ENTSORGUNG DER LEUCHTENKOMPONENTEN



Interrumpir la alimentación del aparato
 Cut the power supply to the luminaire
 Couper l'alimentation du luminaire
 Interrompere l'alimentazione dell'apparecchio
 Stromversorgung der Leuchte unterbrechen



Quitar la(s) fuente(s) de luz para el desecho
 Remove light source(s) for disposal
 Retirer la (les) source(s) lumineuse(s) pour l'élimination
 Rimuovere la/le sorgente/e di luce per lo smaltimento
 Lichtquelle(n) zur Entsorgung entfernen



Quitar la batería para el desecho
 Remove the battery for decommissioning
 Retirer la batterie pour sa mise au rebut
 Rimuovere la batteria per la dismissione
 Die Batterie ordnungsgemäß entsorgen



Quitar el equipo de control para el desecho
 Remove control gear for disposal
 Retirer le dispositif de commande pour l'élimination
 Rimuovere l'alimentatore per lo smaltimento
 Betriebsgerät zur Entsorgung ausbauen

Enviar los materiales a un centro de recogida RAEE
 Send the materials to a WEEE collection centre
 Envoyer les matériaux dans une déchetterie DEEE
 Inviare i materiali ad un centro di raccolta RAEE
 Die Materialien in einem WEEE-Zentrum entsorgen

