

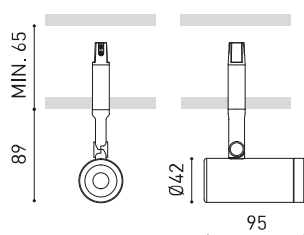

## GRÖÖE

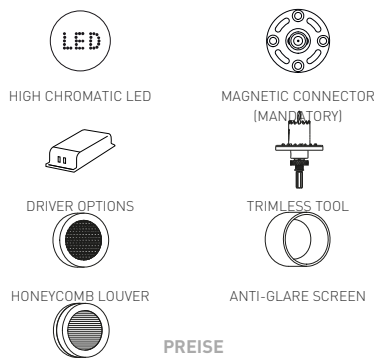

## ZUBEHÖR



## PREISE

LINEAR FILTER



reddot winner 2024  
lighting design

Name	MAGNETIC 24V COCO MEDIUM 4000K NT
Artikelnummer	A4990022NT
Farbe	Schwarz strukturiert
RAL	9005
Kategorie	CEILING RECESSED

## PRODUKT

Typ	LED
Bruttolichtstrom	1340 lm
Farbtemperatur	4000 K
Farbstabilität	MacAdam Step 2
Farbwiedergabeindex	CRI > 90
Leistung	8,7 W
Stromstärke	500 mA
Lichtausbeute	154 lm/W
Nutzlebensdauer der LED in Betriebsstunden	L80B10 > 66.000h

## LICHTQUELLE

Leuchtenwirkungsgrad (LOR)	89%
Abstrahlwinkel	34°

## LEUCHE | PHOTOMETRISCHE DATEN

Driver	Inklusiv
Leistungswerte des Systems	9,62 W
Spannung	24Vdc
Helligkeitssteuerung	DIM-Optionen
Schutzklasse	II

## LEUCHE | ELEKTRISCHE DATEN

Dichtigkeit	IP20
Wireless control	Bitte anfragen
Schwenkwinkel	90°
Drehwinkel	360°
Gewicht	205 g
Gewicht inkl. Verpackung	286 g
Abmessungen der Verpackung	210 x 164 x 57 mm
Stück pro Verpackung	1
Materialien	Aluminium / Polycarbonat / Polymethylmetacrylat

## ANDERE DATEN

Eine unbeschwerte und kraftvolle Lösung. Mit einem hervorragenden lm/W-Verhältnis bietet Coco vier Öffnungswinkel und diverses Zubehör für den Sehkomfort.

POLAR-KOORDINATEN DIAGRAMM



KEGELDIAGRAMM

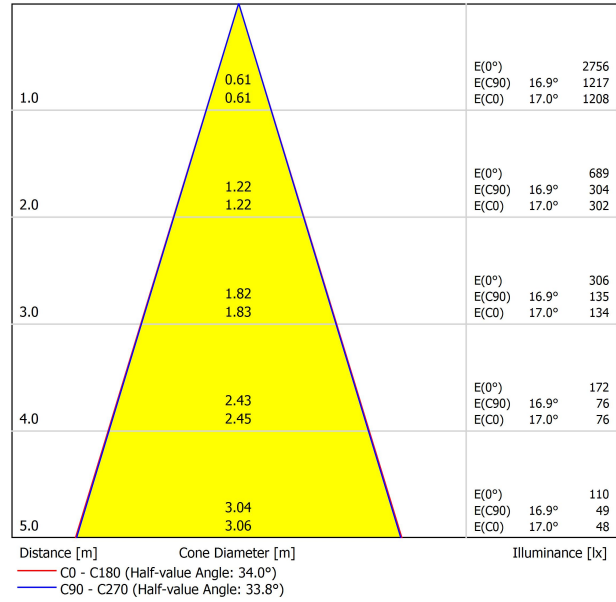

FÜR DIE PRODUKTPRÄSENTATION

Vivid Model Colour Temperature	2700K	3000K	3500K	4000K	Light Pink
📖 Reading			•	•	
🥬 Fruits & Vegetables		•	•		
🍞 Bakery	•				
👤 Retail		•	•		
💄 Cosmetics			•	•	
🥩 Meat					•
🐟 Fish				•	
🐠 Seafood				•	•



Einige der Produkte von Arkoslight können mit einer Spezial-LED für die visuelle Bewerbung von Waren und Produkten zur Verkaufsförderung ausgerüstet werden.

Dabei handelt es sich um eine hochchromatische LED, um Farbtöne hervorzuheben, die positive psychologische Wahrnehmung des beleuchteten Objekts begünstigen.

Diese spezielle LED-Lichtquelle bietet eine ansprechendere und intensivere Farbpalette als eine herkömmliche LED. Dies wird durch die Konfiguration der LED nach einem "speziellen Sättigungsparameter" erreicht, der Farben und Textur der Objekte innerhalb des sichtbaren Spektralbereichs attraktiver erscheinen lässt. Dafür wird die jeweils zweckdienliche Diode und spezifische Phosphorbeschichtung gewählt.

# MAGNETIC 24V CONNECTOR

ARKOSLIGHT®

MANDATORY FOR INSTALLATION

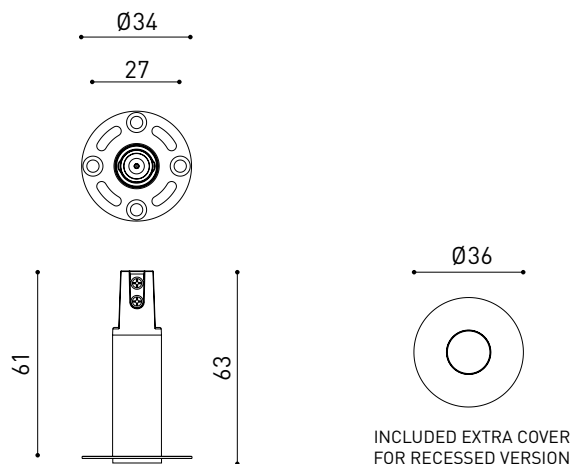

PRODUCT	
Model	Magnetic connector accessory
Reference	A435-01- 00   W <input type="checkbox"/>   N <input checked="" type="checkbox"/>
Category	Accessories



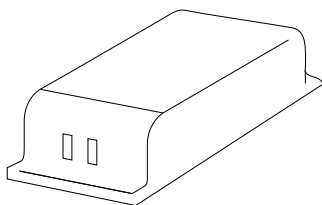

			P	V	D (A x B x C)
24V POWER SUPPLY	ON/OFF	0434-01-37	60W	24V	180 x 52 x 30mm
		0433-10-22	100W	24V	295 x 43 x 30mm

220 V~  
240 V~

MUST BE PLACED ON REMOTE

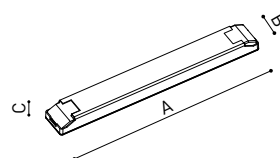

				V	D (A x B x C)
24V Dimmer		0433-01-32	DALI/PUSH	24V	181 x 42 x 20mm
		0433-01-35	CASAMBI	24V	72,6 x 30 x 18mm
		0434-01-64	WIFI	24V	105 x 44 x 23mm

24V

MUST BE PLACED ON REMOTE

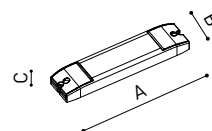

### DROP VOLTAGE TABLE

POWER (W)	CABLE SECTION (mm <sup>2</sup> )	CABLE LENGHT (m)
60	0,75	30
	1,5	30
100	0,75	20
	1,5	30

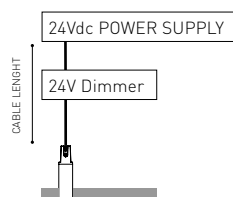



INSTALLATION GUIDE

[https://youtu.be/sa\\_xAgj4ji4](https://youtu.be/sa_xAgj4ji4)

PRODUCT	
Model	Trimless Tool <b>D16 X D34 MM</b>
Reference	A478-00-00
Category	Accessories

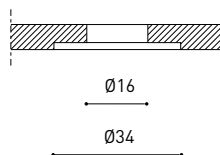
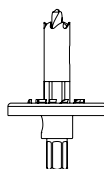



	PRODUCT
Model	Anti-glare Honeycomb Louver
Reference	<b>A498-90-00</b>   WT   NT
Category	Accessories
	NOT SOLD SEPARATELY



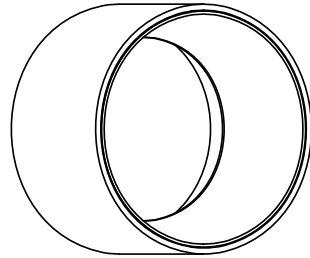

	PRODUCT
Model	Anti-glare Screen
Reference	<b>A498-90-01   WT   NT  </b>
Category	Accessories
	NOT SOLD SEPARATELY







	PRODUCT
Model	Linear Filter
Reference	<b>A498-90-02   WT   NT  </b>
Category	Accessories
	NOT SOLD SEPARATELY <span style="float: right;">SUITABLE FOR BEAM <math>\leq 34^\circ</math></span>



Fuente de luz (LED) reemplazable por un profesional autorizado

Replaceable (LED only) light source by an authorized professional.

Source lumineuse (LED) remplaçable par un professionnel agréé

Sorgente luminosa (LED) sostituibile da parte di un professionista autorizzato

Austauschbare (LED) Lichtquelle durch einen autorisierten Fachmann



Equipo de control reemplazable por un profesional autorizado

Replaceable control gear by an authorized professional

Dispositif de commande remplaçable par un professionnel agréé

Alimentatore sostituibile da parte di un professionista autorizzato

Auswechselbares Betriebsgerät durch autorisierten Fachmann

INSTRUCCIONES PARA EL FINAL DE VIDA Y LA ELIMINACIÓN LOS COMPONENTES  
 INSTRUCTIONS ON END-OF-LIFE AND COMPONENT DISPOSAL  
 INSTRUCTIONS POUR LA GESTION DES COMPOSANTS EN FIN DE VIE ET LEUR MISE AU REBUT  
 ISTRUZIONI PER IL FINE VITA E LO SMALTIMENTO DEI COMPONENTI  
 ANWEISUNGEN ZUR ENTSORGUNG DER LEUCHTENKOMPONENTEN



Interrumpir la alimentación del aparato  
 Cut the power supply to the luminaire  
 Couper l'alimentation du luminaire  
 Interrompere l'alimentazione dell'apparecchio  
 Stromversorgung der Leuchte unterbrechen



Quitar la(s) fuente(s) de luz para el desecho  
 Remove light source(s) for disposal  
 Retirer la (les) source(s) lumineuse(s) pour l'élimination  
 Rimuovere la/le sorgente/e di luce per lo smaltimento  
 Lichtquelle(n) zur Entsorgung entfernen



Quitar la batería para el desecho  
 Remove the battery for decommissioning  
 Retirer la batterie pour sa mise au rebut  
 Rimuovere la batteria per la dismissione  
 Die Batterie ordnungsgemäß entsorgen



Quitar el equipo de control para el desecho  
 Remove control gear for disposal  
 Retirer le dispositif de commande pour l'élimination  
 Rimuovere l'alimentatore per lo smaltimento  
 Betriebsgerät zur Entsorgung ausbauen



Enviar los materiales a un centro de recogida RAEE  
 Send the materials to a WEEE collection centre  
 Envoyer les matériaux dans une déchetterie DEEE  
 Inviare i materiali ad un centro di raccolta RAEE  
 Die Materialien in einem WEEE-Zentrum entsorgen

